

begane grond

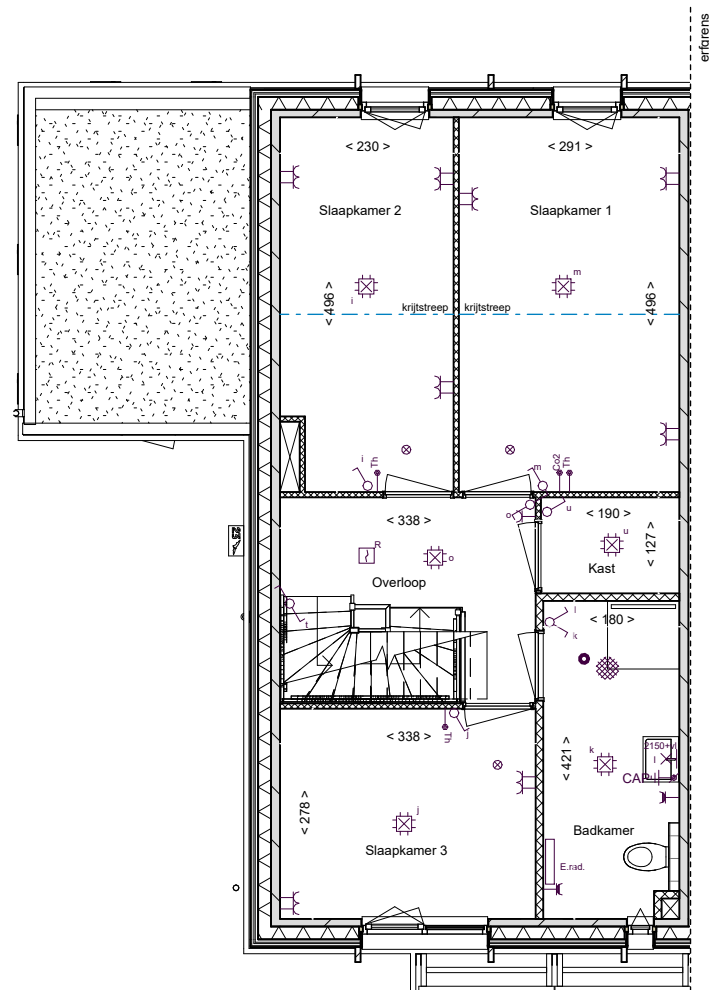

eerste verdieping

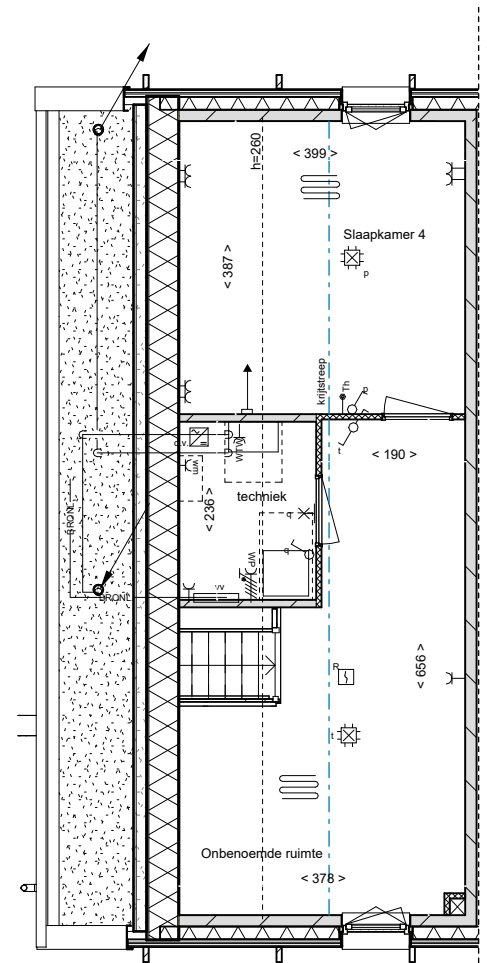

zolder

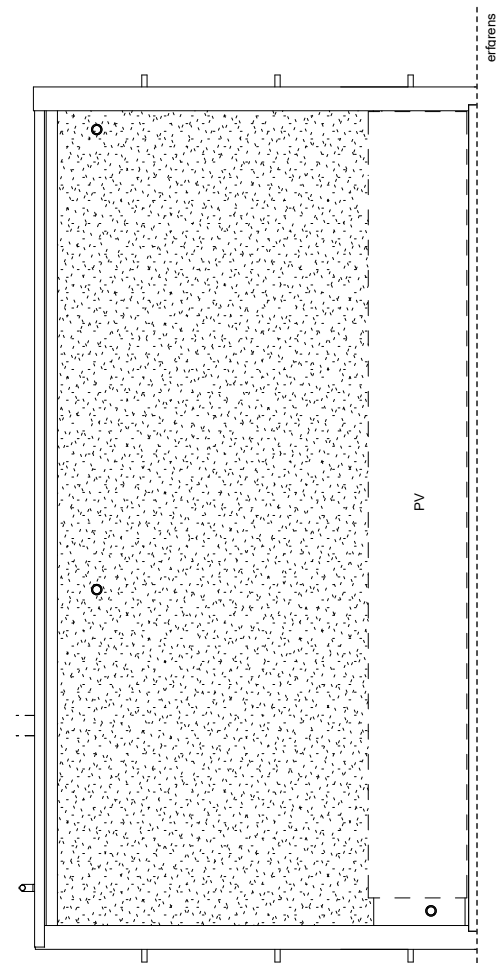

dakaanzicht

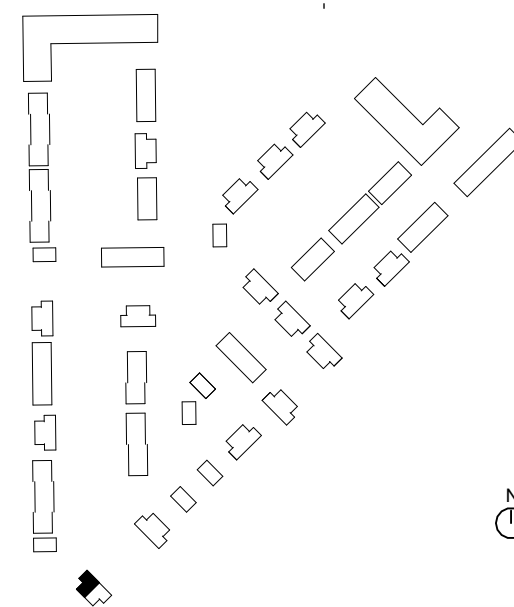

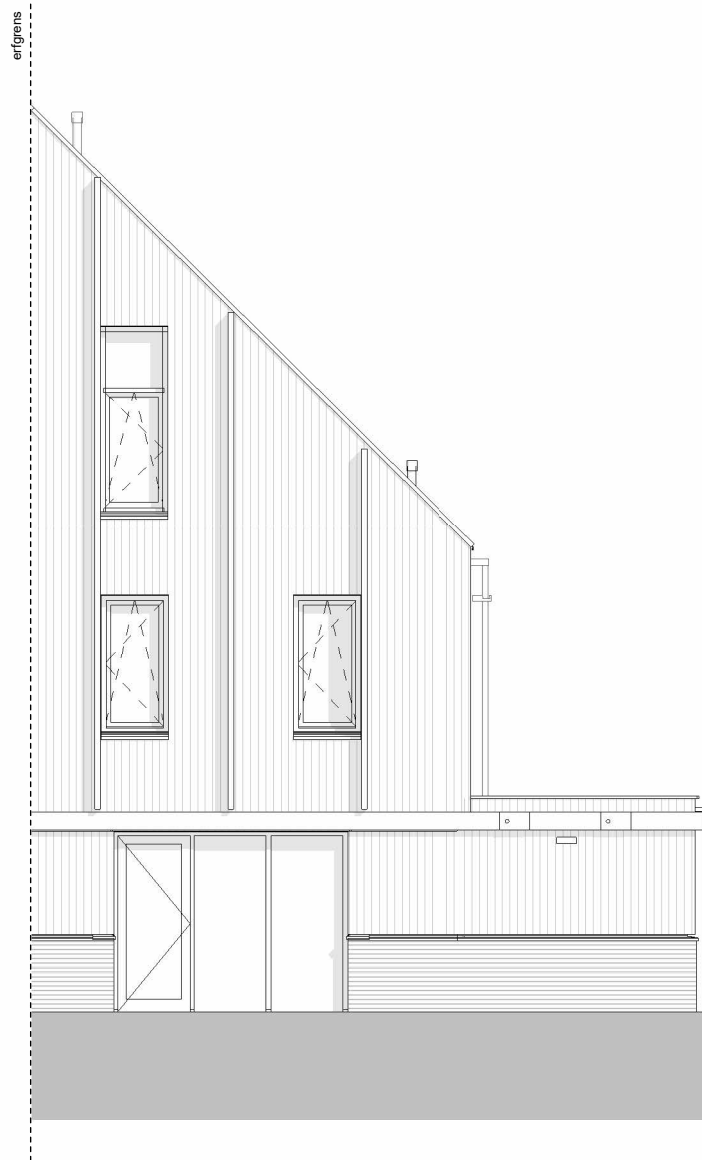

achtergevel (noordoost)

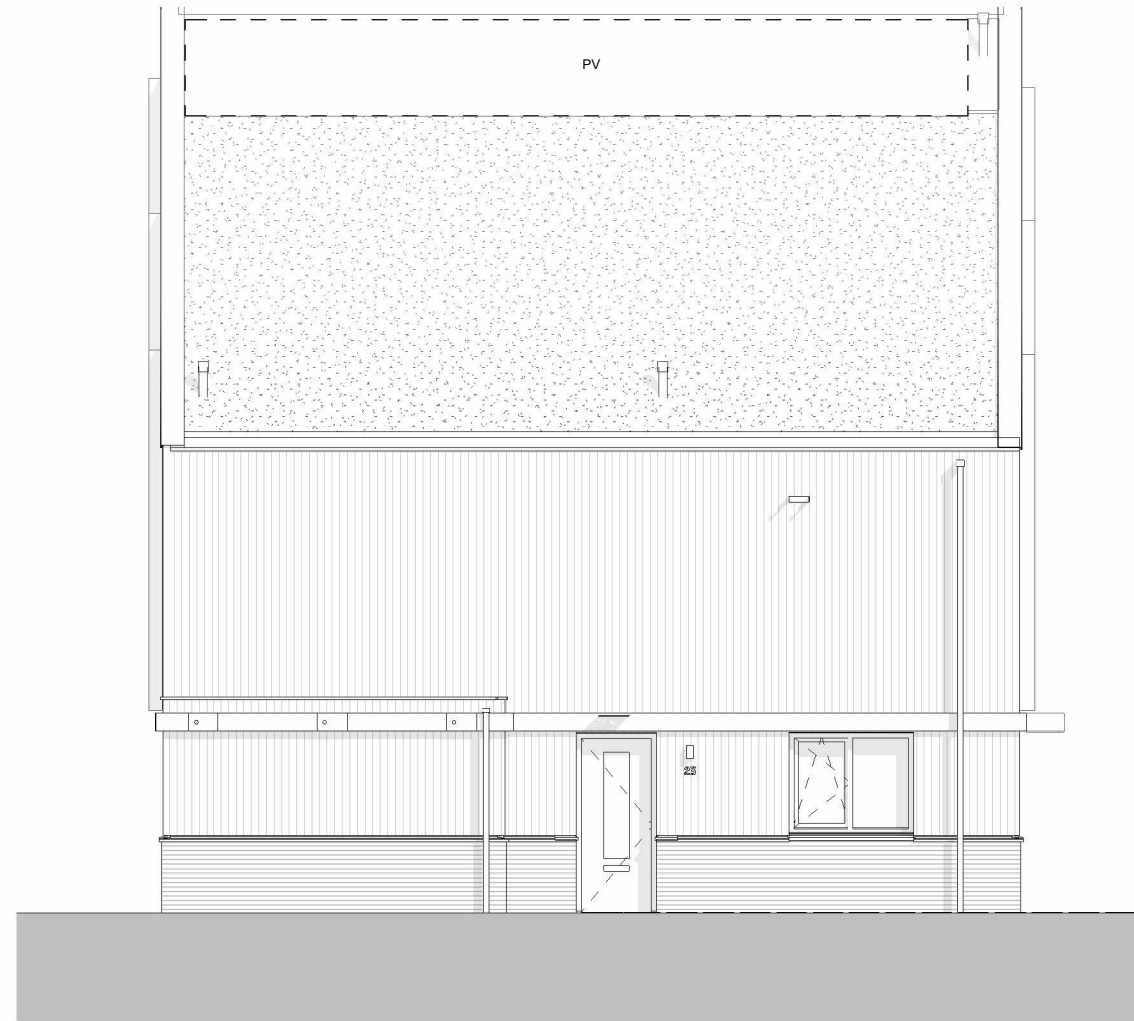

zijgevel (noordwest)

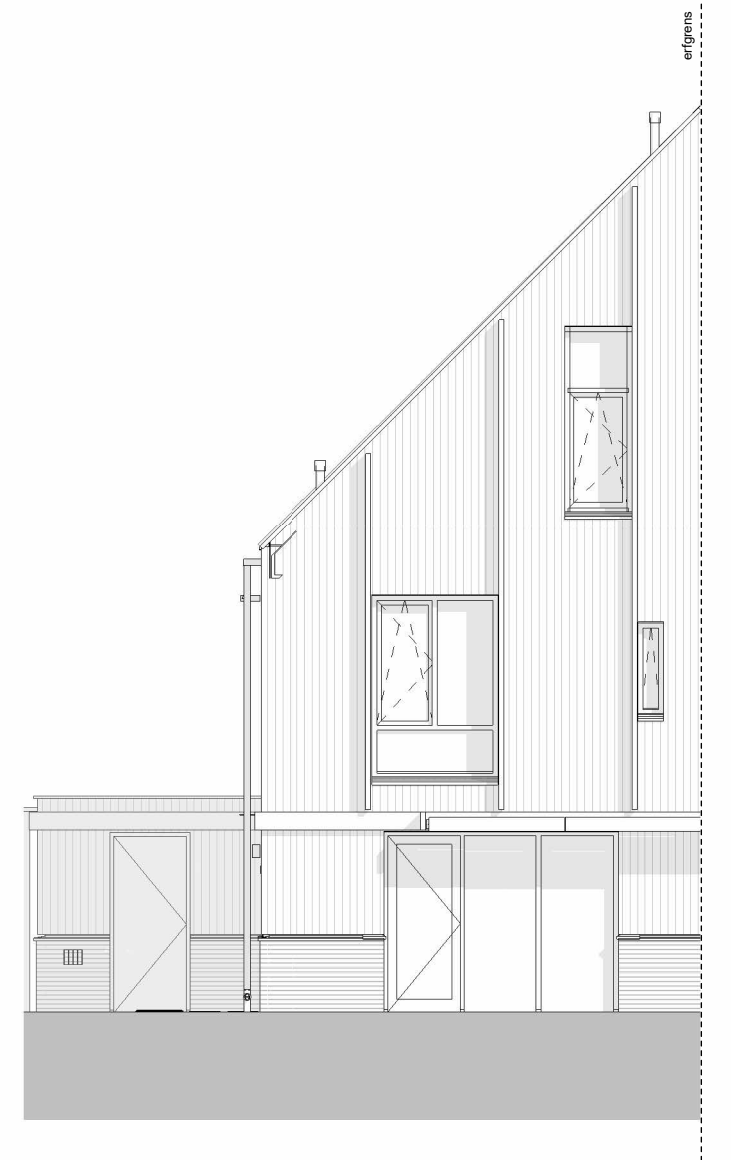

voorgevel (zuidwest)

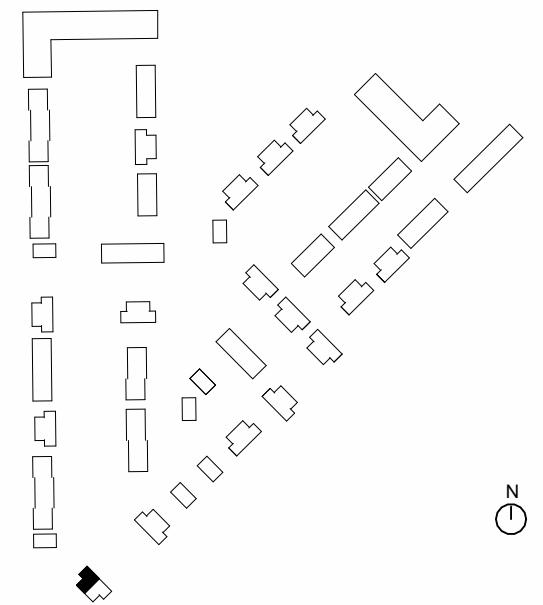

Omschrijving  
**Gevelaanzichten**

Onderdeel Verkooptekening	tekeningnummer <b>VK-017-2</b>	getekend 24-09-2024	schaal 1 : 100	formaat A3
Bouwnummer(s) 17 (2K)				

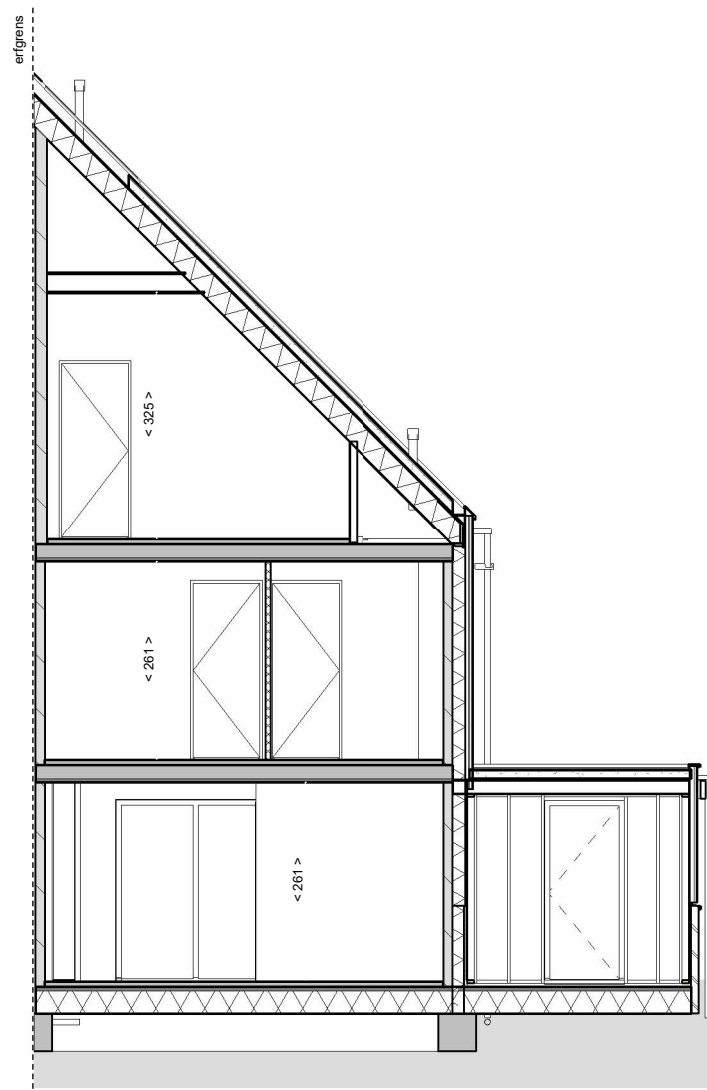

langsdoorsnede

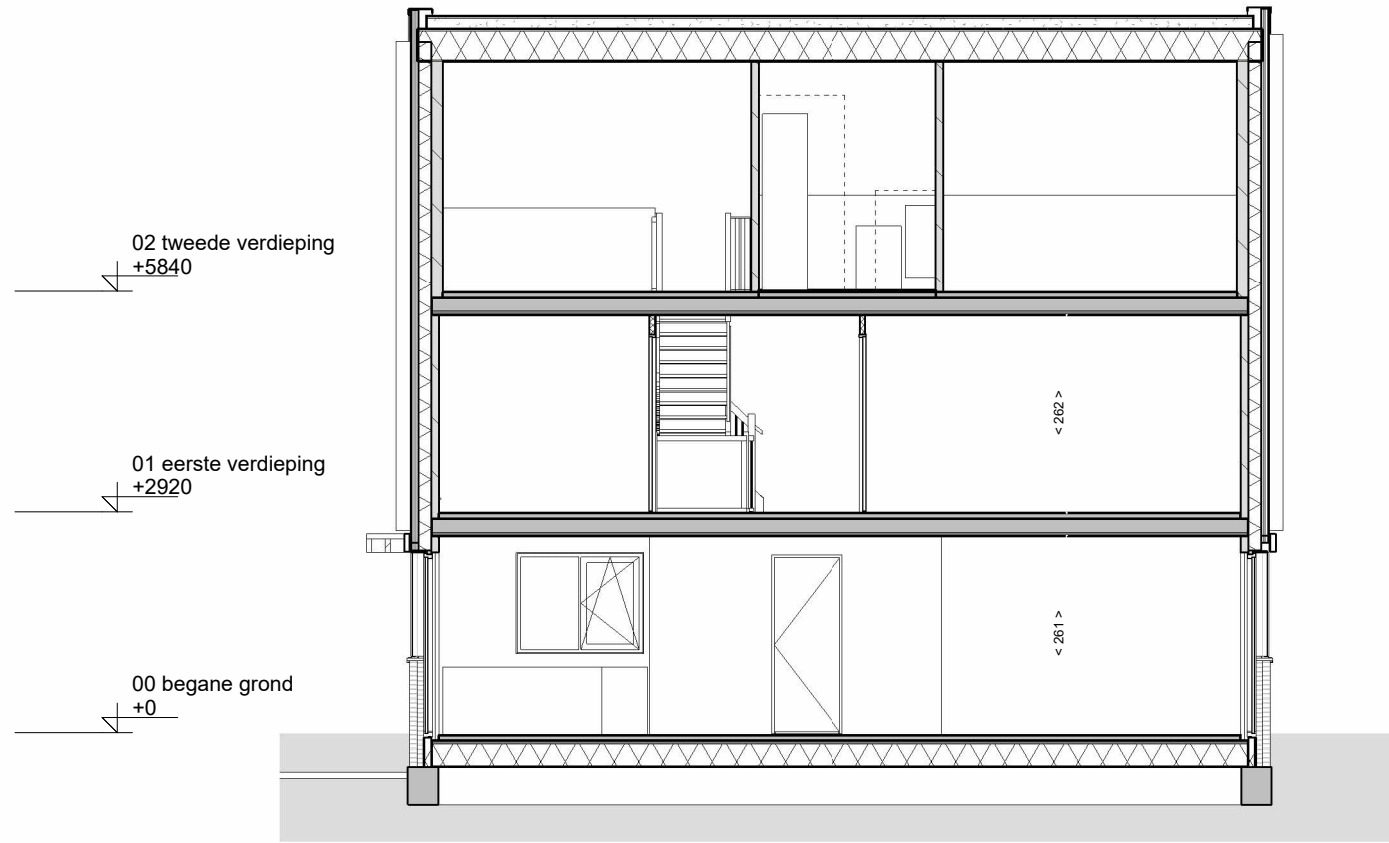

dwarsdoorsnede

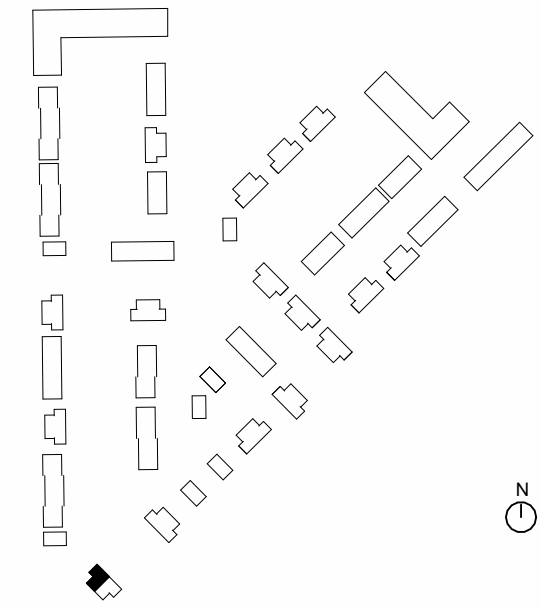
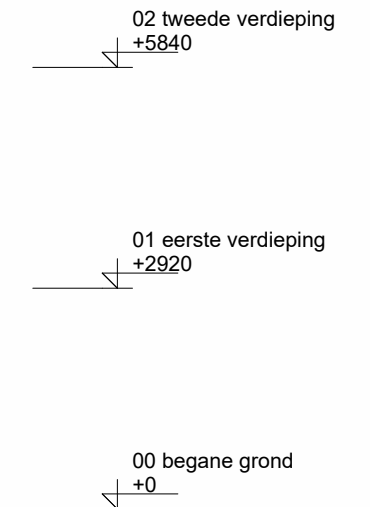

Omschrijving			
<b>Doorsnedes</b>			
Onderdeel	tekeningnummer		
Verkooptekening	<b>VK-017-3</b>		
Bouwnummer(s)	getekend	schaal	formaat
17 (2K)	24-09-2024	1 : 100	A3

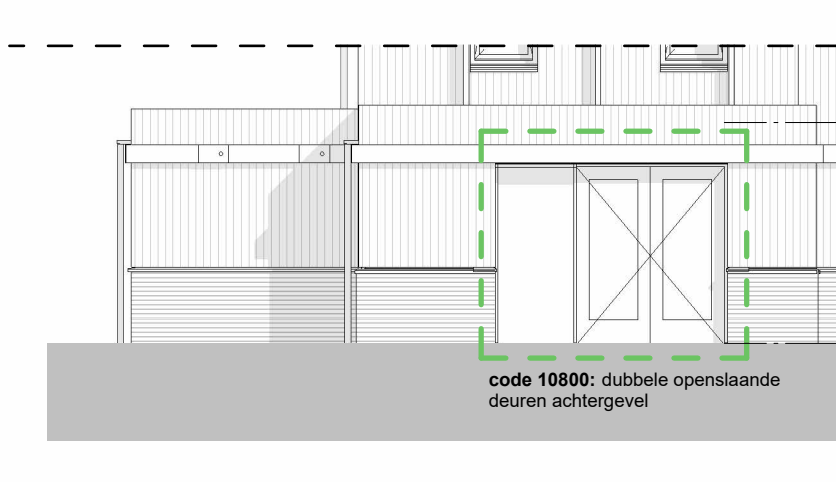

code 10140: uitbouw achtergevel 120cm

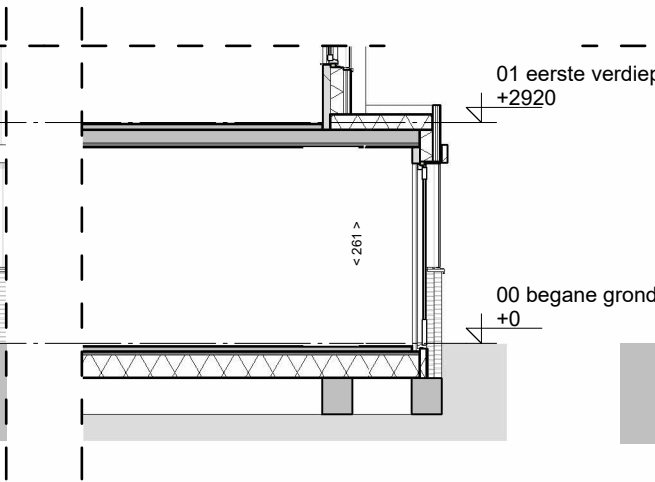

code 10140 / 50: uitbouw achtergevel 120cm

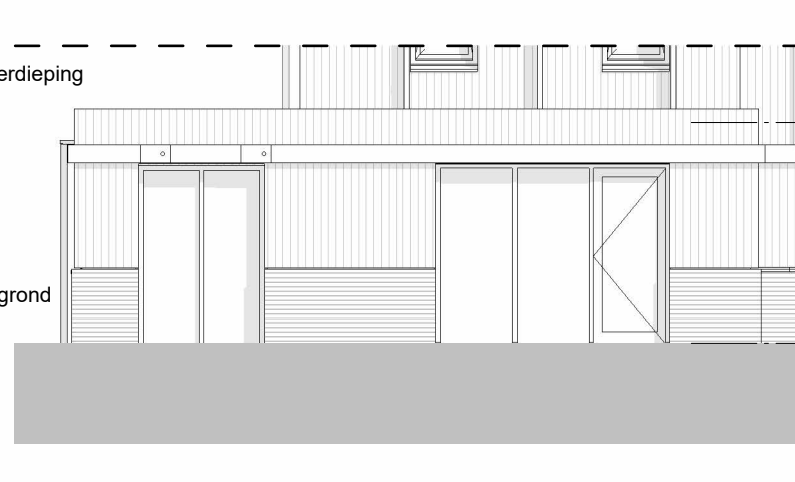

code 10150: uitbouw achtergevel en berging 120cm

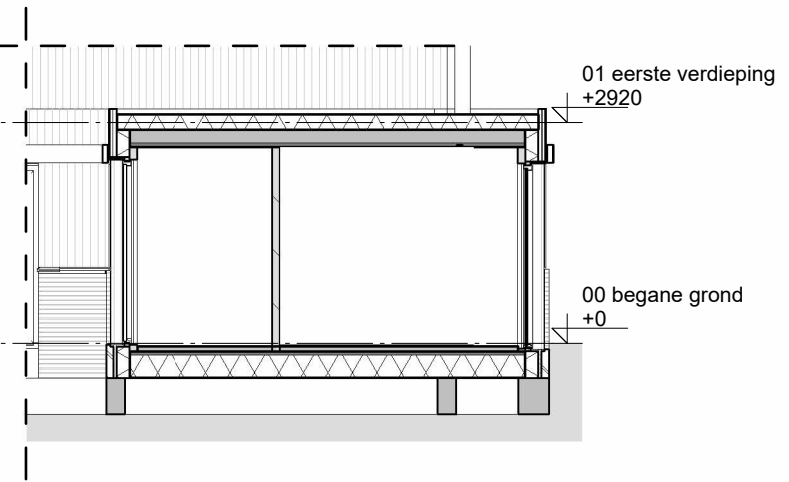

code 10120: uitbouw achtergevel en berging 120cm

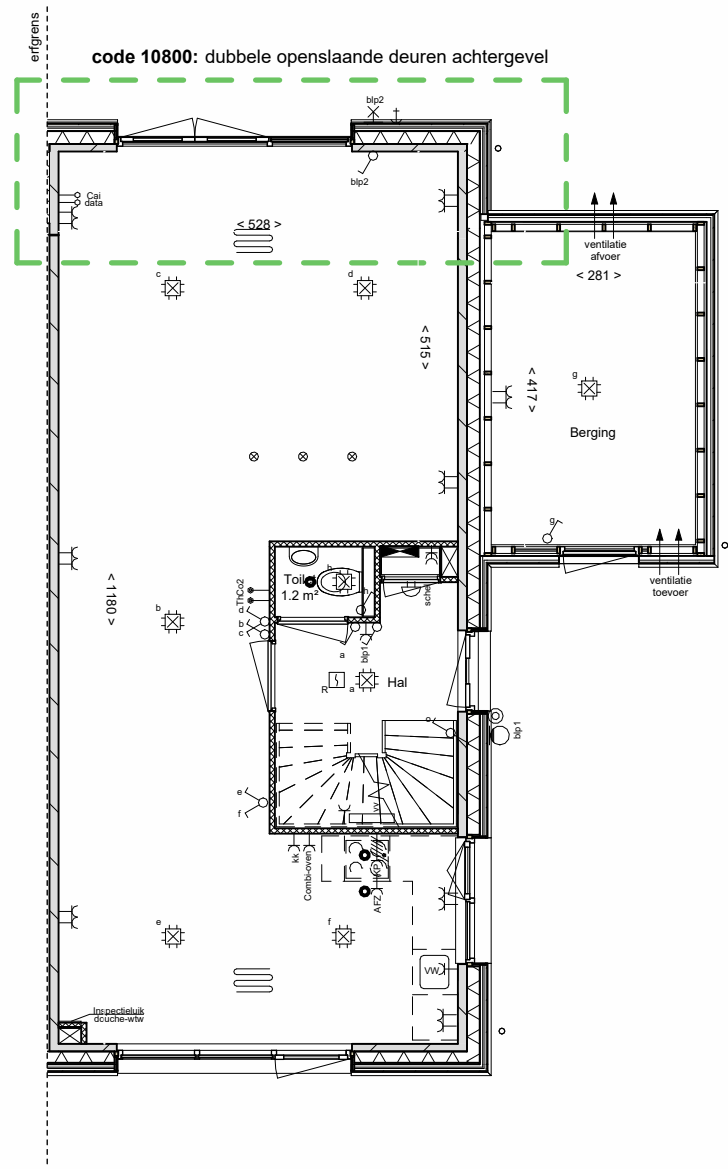

begane grond

code 10140: uitbouw achtergevel 120cm

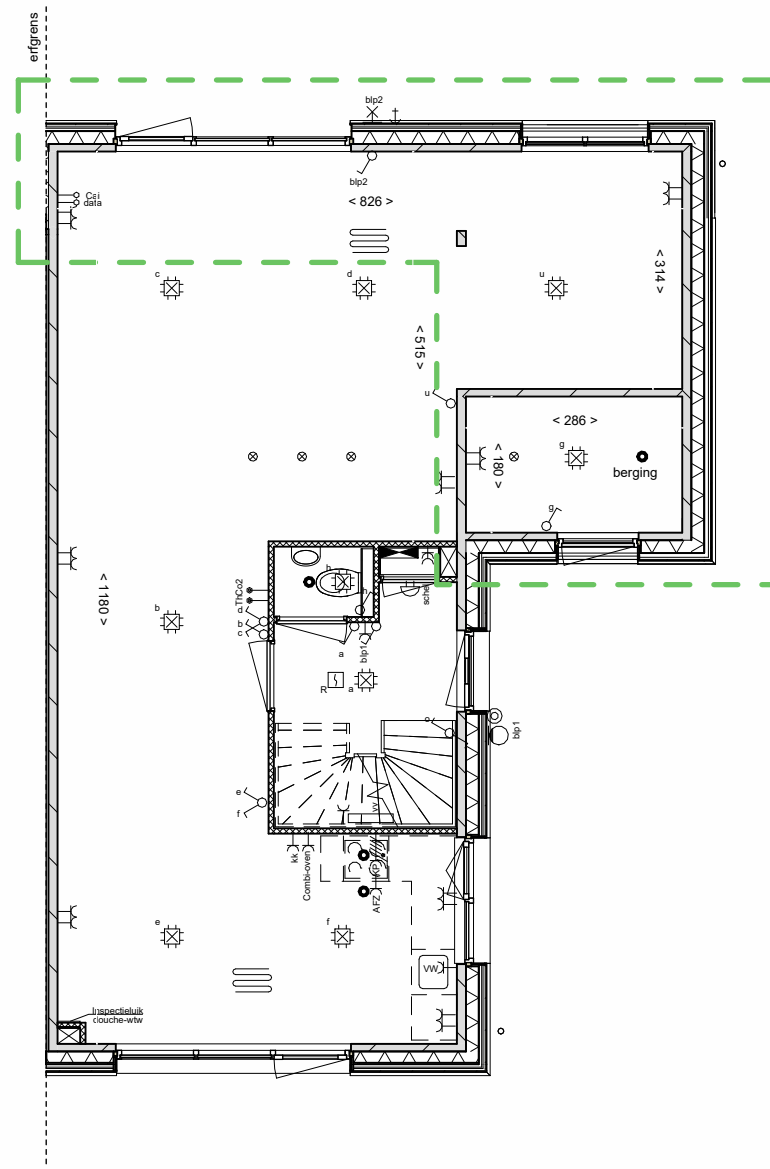

begane grond

code 10150: uitbouw achtergevel en berging 120cm

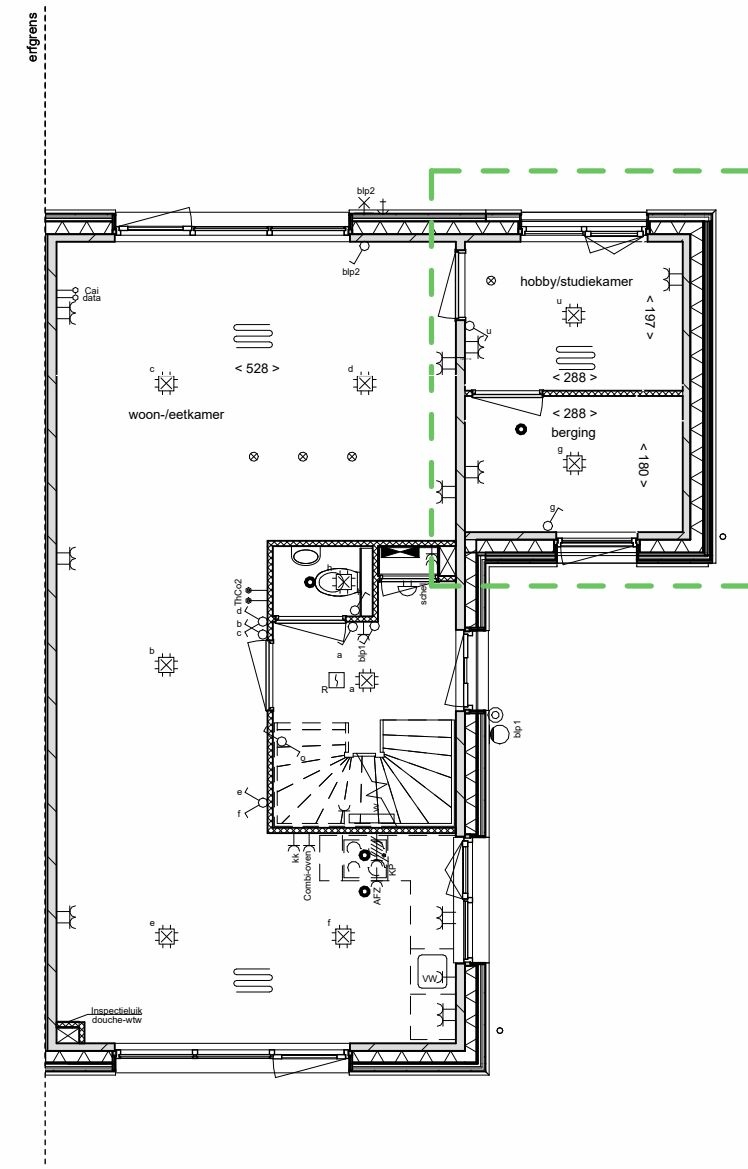

begane grond

code 12010: splitsing berging

**NB:**  
Kopersopties slechts ter indicatie van de extra ruimte en bijbehorende gevelopeningen; materialisatie van de gevel (hout of metselwerk) wijkt mogelijk af van uw bouwnummer.

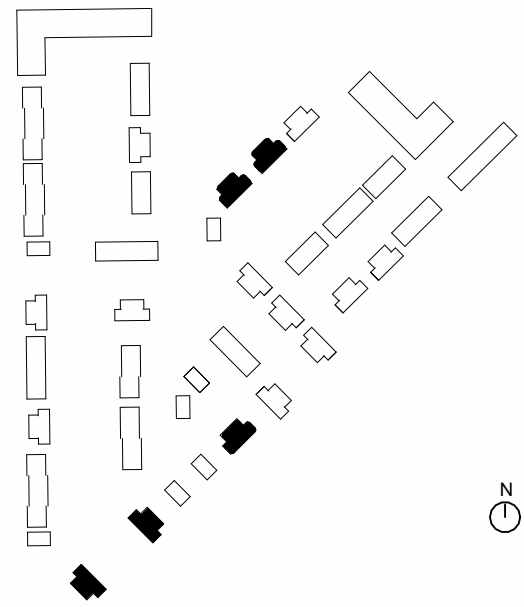

Omschrijving			
<b>Optietekening</b>			
Onderdeel	tekeningnummer		
Verkooptekening	<b>VK-014-4</b>		
Bouwnummer(s)	getekend	schaal	formaat
10-11,14-17,105-108	24-09-2024	1 : 100	A3

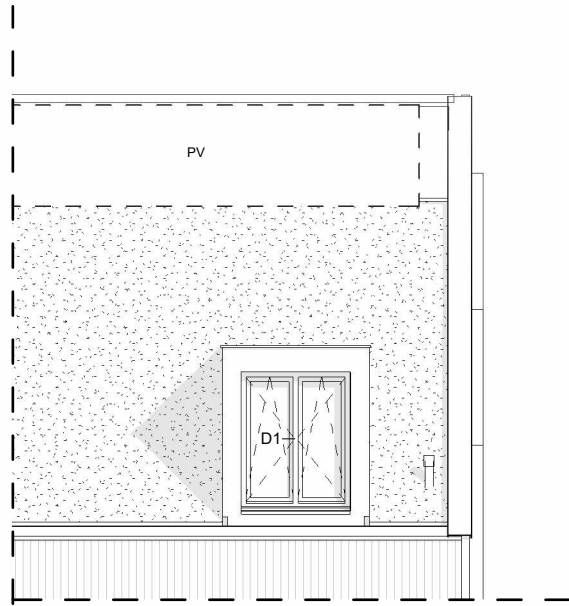

code 10510: dakkapel

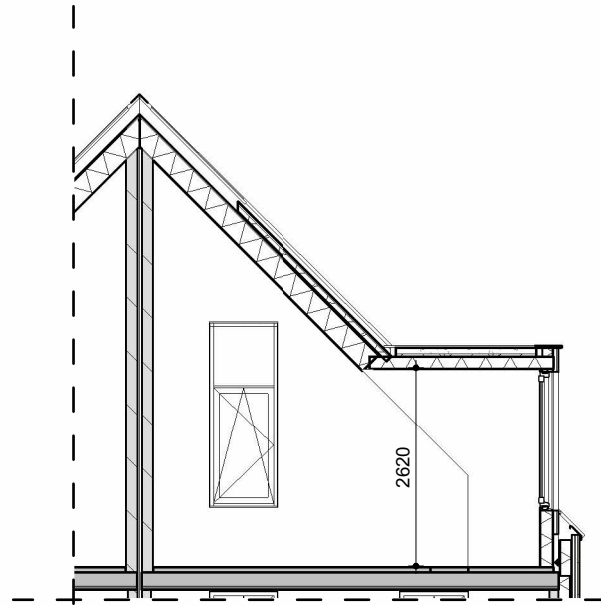

code 10510: dakkapel

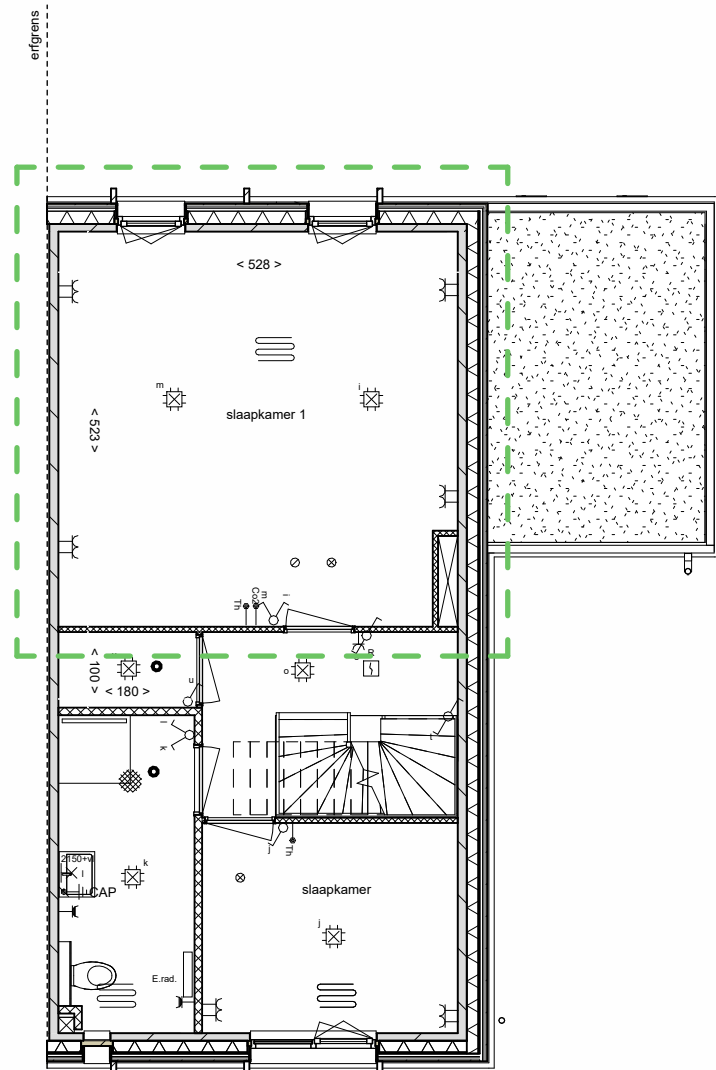

eerste verdieping

code 12145: samengevoegde slaapkamers

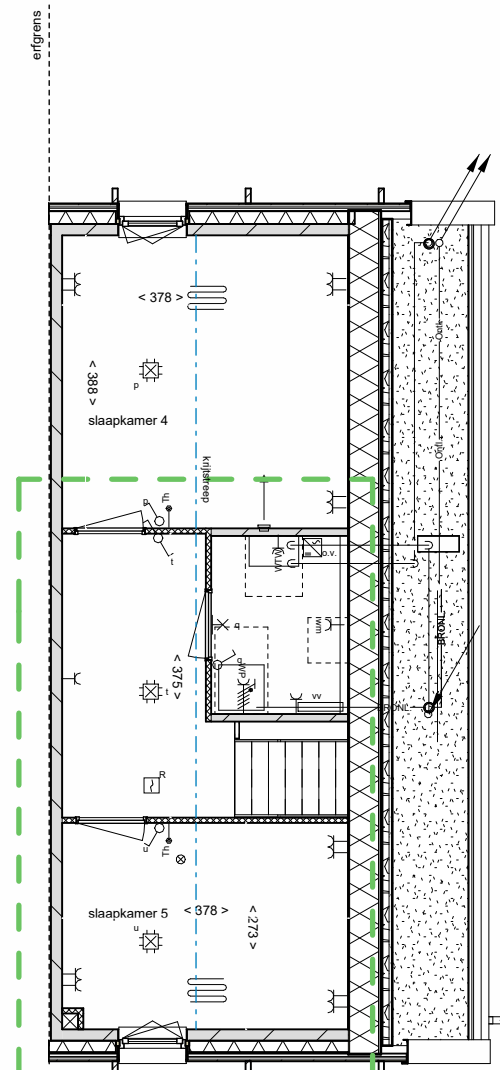

zolder

code 12410: splitsing zolder

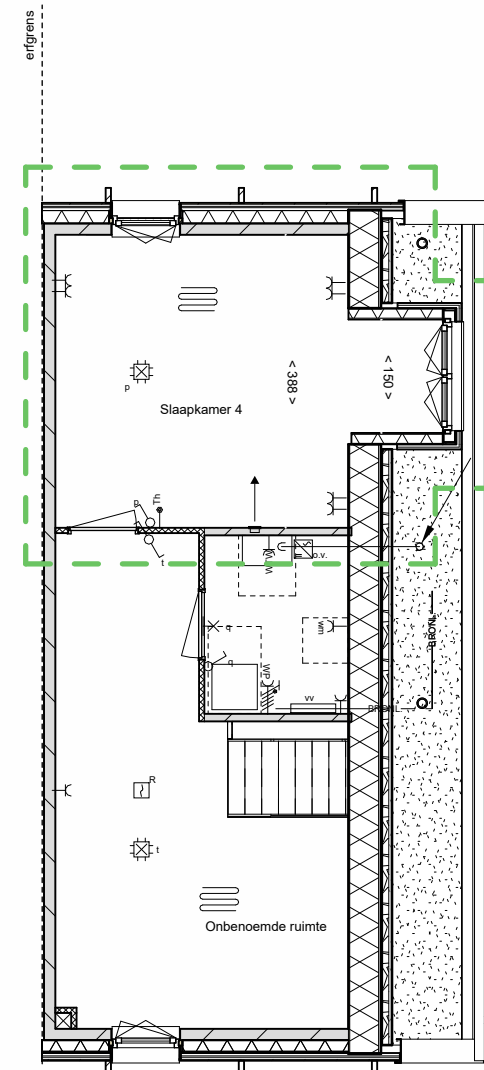

zolder

code 10510: dakkapel

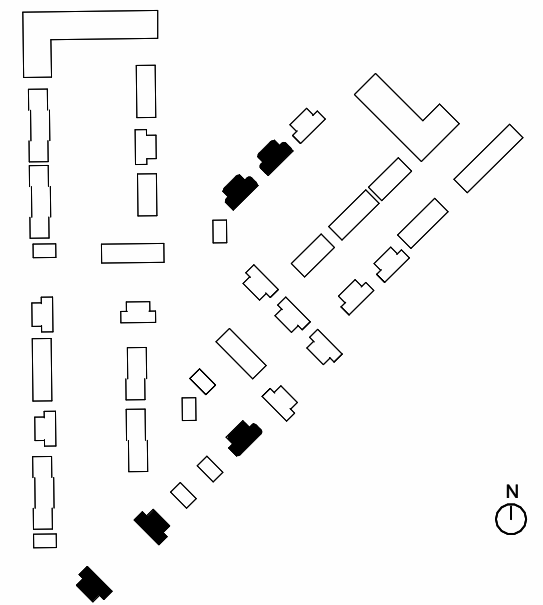

**NB:**  
Kopersopties slechts ter indicatie van de extra ruimte en  
bijbehorende gevelopeningen; materialisatie van de gevel  
(hout of metselwerk) wijkt mogelijk af van uw  
bouwnummer.



Omschrijving  
**Optietekening**

Onderdeel	tekeningnummer		
Verkooptekening	<b>VK-014-5</b>		
Bouwnummer(s)	getekend	schaal	formaat
10-11,14-17,105-108	24-09-2024	1 : 100	A3

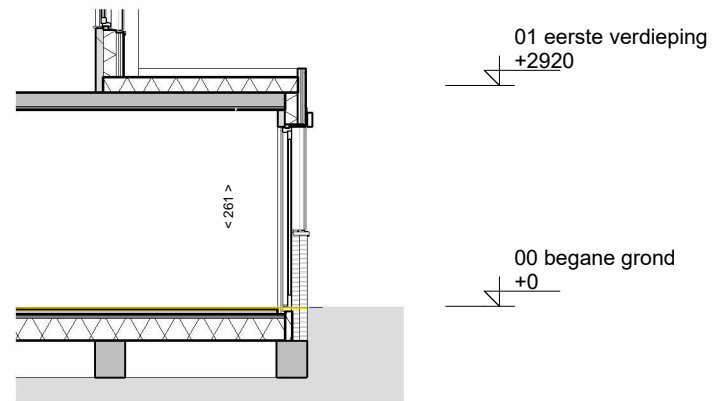

01 eerste verdieping  
+2920

00 begane grond  
+0

code 10145: uitbouw achtergevel 240cm

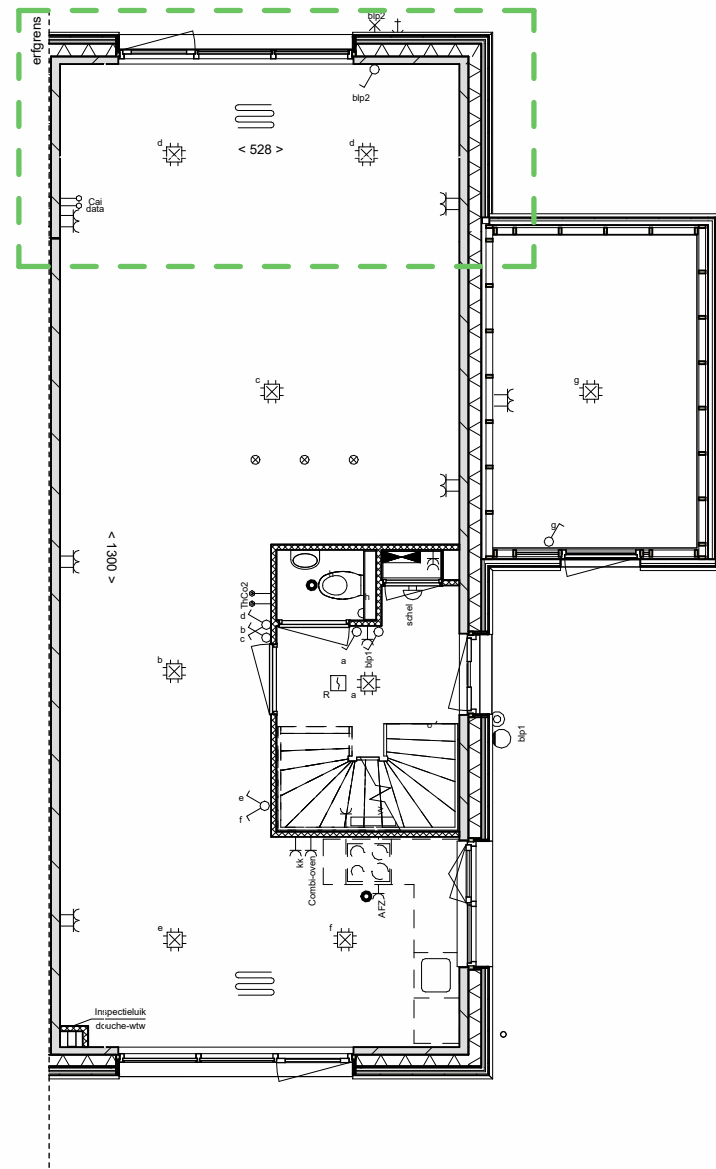

begane grond

code 10145: uitbouw achtergevel 240cm

**NB:**  
Kopersopties slechts ter indicatie van de extra ruimte en  
bijbehorende gevelopeningen; materialisatie van de gevel  
(hout of metselwerk) wijkt mogelijk af van uw  
bouwnummer.

**NB:**  
Opties onder voorbehoud goedkeuring adviseurs.

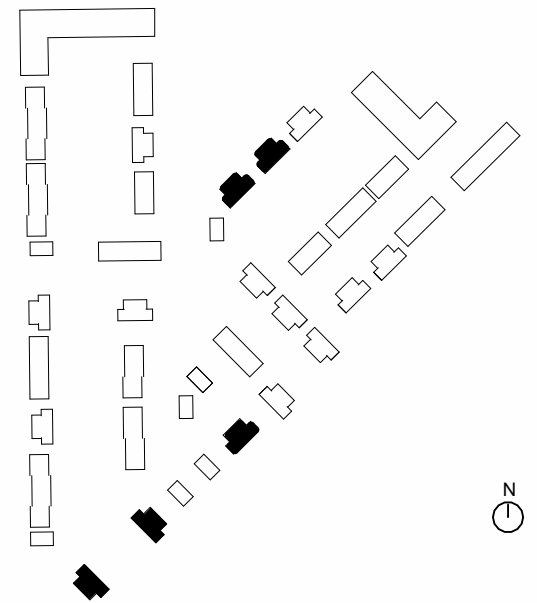

Omschrijving  
**Optietekeningen**

Onderdeel	tekeningnummer		
Verkooptekening	<b>VK-014-6</b>		
Bouwnummer(s)	getekend	schaal	formaat
10-11,14-17,105-108	24-09-2024	1 : 100	A3